



TITLE:
**SPECIFICATION FOR
PERSONAL PROTECTIVE
EQUIPMENT - PROTECTIVE
CLOTHING**
Part 4: High visibility clothing

Doc. No.	KP1/6C/13/TSP/01/025-4
Issue No.	1
Revision No.	0
Date of Issue	2015-10-12
Page 1 of 19	

TABLE OF CONTENTS

0.1 Circulation List

0.2 Amendment Record

FOREWORD

1. SCOPE
2. REFERENCES
3. TERMS AND DEFINITIONS
4. REQUIREMENTS
5. TESTS AND INSPECTION
6. MARKING, LABELLING AND PACKING
7. DOCUMENTATION

ANNEX A: *Guaranteed Technical Particulars (to be filled and signed by the Manufacturer's and submitted together with copies of the manufacturer's catalogues, brochures, drawings, technical data, copies of previous test reports, list of customers and reference letters from four previous customers for tender evaluation)*

ANNEX B: *Designs of Protective Clothing (various items)*

Issued by: Head of Section, Standard Development

Authorized by: Head of Department, Standards

Signed:

Signed:

Date: 2015-10-12

Date: 2015-10-12



TITLE:
**SPECIFICATION FOR
PERSONAL PROTECTIVE
EQUIPMENT - PROTECTIVE
CLOTHING**
Part 4: High visibility clothing



Doc. No.	KP1/6C/13/TSP/01/025-4
Issue No.	1
Revision No.	0
Date of Issue	2015-10-12
Page 2 of 19	

0.1 Circulation List

NO.	COPY HOLDER
1	Manager, Standards
Electronic copy (pdf) on Kenya Power Server (currently: Network→stima-fprnt-001→techstd&specs)	

0.2 Amendment Record

Rev No.	Date (YYYY-MM-DD)	Description of Change	Prepared by (Name & Signature)	Approved by (Name & Signature)
0	2015-10-12	New Issue	Michael Apudo	Dr. Eng. Peter Kimemia 

Issued by: Head of Section, Standard Development	Authorized by: Head of Department, Standards
Signed: 	Signed: 
Date: 2015-10-12	Date: 2015-10-12



TITLE:
**SPECIFICATION FOR
PERSONAL PROTECTIVE
EQUIPMENT - PROTECTIVE
CLOTHING**

Part 4: High visibility clothing

Doc. No.	KP1/6C/13/TSP/01/025-4
Issue No.	1
Revision No.	0
Date of Issue	2015-10-12
Page 3 of 19	

FOREWORD

This specification has been prepared by the Standards Department in collaboration with Human Resource Services Department; Safety, Health & Environment (SHE) Department of The Kenya Power and Lighting Company Limited (KPLC/Kenya Power) and The Kenya Electrical Trade & Allied Workers Union (KETAWU). The specification lays down requirements for – High Visibility Clothing. It is intended for use by Kenya Power in purchasing these items.

The supplier shall submit information which confirms satisfactory service experience with products which fall within the scope of this specification

1. SCOPE

- 1.1. This document specifies the design and performance, methods of test, marking and user information for high visibility garments for use in Industrial Work (Electrical and Mechanical) by Kenya Power company employees. It also outlines the high visibility requirements for garments to be worn by employees for enhancing their visibility while working in or adjacent to moving traffic, heavy equipment, work zones or other endangering elements.
- 1.2. The specification covers performance requirements for the garments made from flexible materials, which are designed to protect the wearer's body, except the hands, from heat, flame, and chemical substances. This shall include:
 - a) High visibility jacket
 - b) High visibility vests
- 1.3. The specification stipulates the minimum requirements for the jackets in the company and it shall be the responsibility of the supplier to ensure adequacy of the design, good engineering practice, adherence to the specification and applicable standards and regulations as well as ensuring good workmanship in the manufacture of the items for The Kenya Power & Lighting Company.
- 1.4. The specification does not purport to include all the necessary provisions of a contract.

2.0. REFERENCES

The following standards contain provisions which, through reference in this text constitute provisions of this specification. Unless otherwise stated, the latest editions (including amendments) apply.

Issued by: Head of Section, Standard Development

Authorized by: Head of Department, Standards

Signed:

Signed:

Date: 2015-10-12

Date: 2015-10-12



TITLE:
**SPECIFICATION FOR
PERSONAL PROTECTIVE
EQUIPMENT - PROTECTIVE
CLOTHING**

Part 4: High visibility clothing

Doc. No.	KP1/6C/13/TSP/01/025-4
Issue No.	1
Revision No.	0
Date of Issue	2015-10-12
Page 4 of 19	

- ISO 20471: High visibility clothing -- Test methods and requirements
- ISO 105: Textiles -- Tests for colour fastness -- Part B02: Colour fastness to artificial light: Xenon arc fading lamp test; -- Part E04: Colour fastness to perspiration
- BS EN 340: Protective clothing: General requirements
- BS EN 1413: Textiles. Determination of pH of aqueous extract
- BS EN 14362-1: Textiles. Methods for determination of certain aromatic amines derived from azo colorants. Detection of the use of certain azo colorants accessible with and without extracting the fibres
- BS EN 1150: Protective clothing. Visibility clothing for non-professional use. Test methods and requirements
- BS EN 13402-2: Size designation of clothes. Primary and secondary dimensions
- KS 836-2: Classification and terminology of stitches and seams — Part 2: Seam types.
- KS 836-1: Classification and terminology of stitches and seams Part 1: Types – Ready-made garments.
- KS ISO 13935-1: Textiles -- Seam tensile properties of fabrics and made-up textile articles -- Part 1: Determination of maximum force to seam rupture using the strip method

3.0. TERMS AND DEFINITIONS

- 3.1. The definitions given in the reference standard shall apply.
- 3.2. Kenya Power Logo – As per sample available with Human Resource & Administration Division, Kenya Power.

4.0. REQUIREMENTS

4.1. OPERATING CONDITIONS

The high visibility jackets and vests shall be suitable for use in Electrical and Mechanical Work, outdoors in tropical climate with:

- a) Altitudes of up to 2200m above sea level,
- b) Humidity of up to 95%,
- c) Average ambient temperature of +30°C with a minimum of -1°C and a maximum of +40°C.

Issued by: Head of Section, Standard Development	Authorized by: Head of Department, Standards
Signed:	Signed:
Date: 2015-10-12	Date: 2015-10-12



TITLE:
**SPECIFICATION FOR
PERSONAL PROTECTIVE
EQUIPMENT - PROTECTIVE
CLOTHING**
Part 4: High visibility clothing

Doc. No.	KP1/6C/13/TSP/01/025-4
Issue No.	1
Revision No.	0
Date of Issue	2015-10-12
Page 5 of 19	

4.2. HIGH VISIBILITY CLOTHINGS

4.2.1. General requirements

The high visibility clothing shall be manufactured incorporating separate and combined performance materials as per BS EN 1150 and ISO 20471 and shall comprise of:

a) Background (fluorescent) materials

The background (fluorescent) material shall be evenly distributed around the body and shall be applied so that the minimum width is not less than 50mm. Any gap for fastening shall not be greater than 50mm and the total area of such gaps shall not be greater than 100mm² in any one band. The material colour shall be fluorescent yellow with properties as per Table 1.

b) Retro-reflective materials

The retro-reflective material shall be evenly distributed to all aspects of the body covered by the background material. The retro-reflective material shall be applied in the band and the logo. The individual area of retro-reflective material shall not be less than 25cm² and the minimum width shall not be less than 25mm. The retro-reflective material shall use a glass bead technology or prismatic technology (or high gloss) in order to achieve a maximum 360° visibility with 8910 Silver Trim colour such as Scotchlite reflective material.

The retro-reflective band shall be BS EN 1150 or ISO 20471 approved and certified by an accredited laboratory to ISO/IEC 17025 (Certificate to be attached during tender). Glass bead type retro-reflective band shall be certified for 30 washes at 60°C. The reflective material shall have a minimum reflectivity of 500cd/lux. Retro-reflective material shall be visible from 300metres.

4.2.2. Requirements of background material and combined performance material

- 4.2.2.1. All the requirements BS EN 340 and clause 4.2 of this specification shall be adhered to in the design, manufacture and testing of the clothing.
- 4.2.2.2. The colour and luminance factor of new background material and combined performance material shall be within the region of Table 1 & 2 when tested in accordance with clause 7.2 of BS EN 1150.

Issued by: Head of Section, Standard Development

Authorized by: Head of Department, Standards

Signed:

Signed:

Date: 2015-10-12

Date: 2015-10-12

Table 1: Colour coordinates for background material and combined performance as per BS EN 1150

Colour	Chromaticity coordinates		Material minimum luminance factor	
	X	Y	Background	Combined performance
Fluorescent yellow	0.387	0.610	0.76	0.70
	0.356	0.494		
	0.398	0.452		
	0.460	0.540		

Table 2: Colour fastness as per BS EN 1150

Care process	Test method	Fastness grade of grey scale, min
Domestic and commercial laundering	EN ISO 105-106C, method C2S	Colour change: 4 to 5 Staining: 3
Dry cleaning	EN ISO 105-D01	Colour change: 4
Hot pressing	EN ISO 105-X11	Colour change: 4 to 5 Staining: 4
After xenon test	EN 20105-B02	Exposure shall continue until the blue scale control number 4 changes to step 4 of the grey scale

4.2.3. Retro-reflective performance requirements

Retro-reflective and combined performance material shall comply with the requirements of Table 3.

Table 3: Minimum performance requirement for retro-reflective material

Exposure	Test method	Results
Abrasion	EN 530	5,000 cycles
Flexing	ISO 7854 method A	7,500 cycles
Folding at cold temperatures	ISO 4675	(-20±1)°C
Temperatures variation	BS EN 1150 clause 7.4.3	(-50±1)°C
Washing	ISO 6330 method 2A	Pass
Dry cleaning	EN ISO 3175	
Convective Heat: RA≥ 100		10 minutes @ 140 °C (285 °F)
Wet Reflectivity: RA≥ 100	EN 471, Annex D	
Coefficient of retro-reflective material R', measured at observation angle 12° and entrance angle 5°	CIE 54 and BS EN 1150 clause 7.3	>100 cd lx ⁻¹ m ⁻²
Coefficient of combined performance material R', measured at observation angle 12° and entrance angle 5°	BS EN 1150 clause 7.5	>30 cd lx ⁻¹ m ⁻²
Coefficient of retro-reflection for retro-reflective material	Annex A of ISO 20471 and BS EN 1150 clause 7.5	>15 cd lx ⁻¹ m ⁻²

Issued by: Head of Section, Standard Development

Authorized by: Head of Department, Standards

Signed:



Signed:



Date: 2015-10-12

Date: 2015-10-12



TITLE:
**SPECIFICATION FOR
PERSONAL PROTECTIVE
EQUIPMENT - PROTECTIVE
CLOTHING**

Part 4: High visibility clothing

Doc. No.	KP1/6C/13/TSP/01/025-4
Issue No.	1
Revision No.	0
Date of Issue	2015-10-12
Page 7 of 19	

4.3. HIGH VISIBILITY JACKET

4.3.1. General

- 4.3.1.1. The high visibility jacket (Garments covering the torso and arms) shall be ISO 20471 - class 3 or BS EN 1150 class 3 compliant, water resistant, soft shell athletic jacket with a stretchable three (3) layer fabric construction.
- 4.3.1.2. The body material shall consist two fused portions namely:
- a) Upper portion above the top retro-reflective band and the sleeves made of a two (2)-tone high visibility fluorescent yellow material.
 - b) Lower portion made of a 100% polyester material with a soft outer shell and Pantone Blue 288PC in colour,
- 4.3.1.3. The jacket lining material properties shall consist of a breathable, waterproof and windproof TPU (thermoplastic polyurethane) membrane with a warm and comfortable brushed fleece.

4.3.2. Specific design requirements

- 4.3.2.1. The high visibility jacket shall meet, as a minimum, the requirements for Class 3 garments set out in Table 1 of ISO 20471.
- 4.3.2.2. The high visibility jacket shall consist of background material, background contrasting material and retro-reflective materials;
- a) **Background material**
The background material fabric shall have all the qualities described in clauses 4.2.2.1 and 4.2.2.2. The fabric shall be a high contrast FR 150D oxford polyester or equivalent with internal polyurethane coating.
 - b) **Background contrasting material**
The fabric for background contrasting material shall be a Blue Pantone 288PC in colour, 100% polyester with internal polyurethane coating.
 - c) **Retro-reflective material**
The retro-reflective material shall conform to qualities described in clause 4.2.3. The fabric shall be 50mm, 8910 Silver Trim colour.

Issued by: Head of Section, Standard Development

Authorized by: Head of Department, Standards

Signed:

Signed:

Date: 2015-10-12

Date: 2015-10-12



TITLE:
**SPECIFICATION FOR
PERSONAL PROTECTIVE
EQUIPMENT - PROTECTIVE
CLOTHING**
Part 4: High visibility clothing

Doc. No.	KP1/6C/13/TSP/01/025-4
Issue No.	1
Revision No.	0
Date of Issue	2015-10-12
Page 8 of 19	

- 4.3.2.3. The background (fluorescent) material shall encircle all relevant parts (torso and arms) with a minimum width of 50mm. Allowable gaps for fastening systems and seams shall remain the same.
- 4.3.2.4. The sleeve shall be surrounded by two retro-reflective bands with at least 50 mm from each other, with the lower band at least 50 mm from the end of the sleeve.
- 4.3.2.5. The total visible areas for the fluorescent material shall be roughly equal on the front and back of a garment and shall be fluorescent yellow.
- 4.3.2.6. The reflective bands shall be inset at least 50mm from the bottom edge of the jacket, sleeve and no reflective band shall have a gap in it more than 50mm wide (for fastenings etc.) and the total gaps in a single band shall not exceed 100mm for the torso and sleeves.
- 4.3.2.7. The minimum total visible areas of fluorescent and reflective material - Class 3 shall be 0.8m² and 0.2m² (about 12¾ and 3¾ sheets of A4 paper).
- 4.3.2.8. The jacket shall have a stand-up collar of approximately 100mm in height and be well shaped and symmetrical. There shall be a 26mm² nylon coil zipper measuring approximately 215mm long sewn approximately 60mm from the top of the collar that shall hide the drop in three (3)-piece waterproof hood.
- 4.3.2.9. The jacket shall have a Val cover over the zipper. The side panels of the hood shall measure approximately 280mm in height x 200mm in width. The middle piece of the three (3) piece hood shall measure approximately 115mm wide and be sewn single needle raised.
- 4.3.2.10. The hood shall be shaped to allow peripheral vision. The hood shall be finished with elastic shock cords with tension loaded barrel locks for proper adjustment.
- 4.3.2.11. Additional features of the jacket shall be:
 - a) Zip closure with tunnel collar
 - b) Zippered side waist pockets
 - c) Zippered cell phone pocket at the chest
 - d) Draw string hem with barrel lock
 - e) Quick adjust rubber tab fastener with hook & loop cuffs.

Issued by: Head of Section, Standard Development	Authorized by: Head of Department, Standards
Signed:	Signed:
Date: 2015-10-12	Date: 2015-10-12

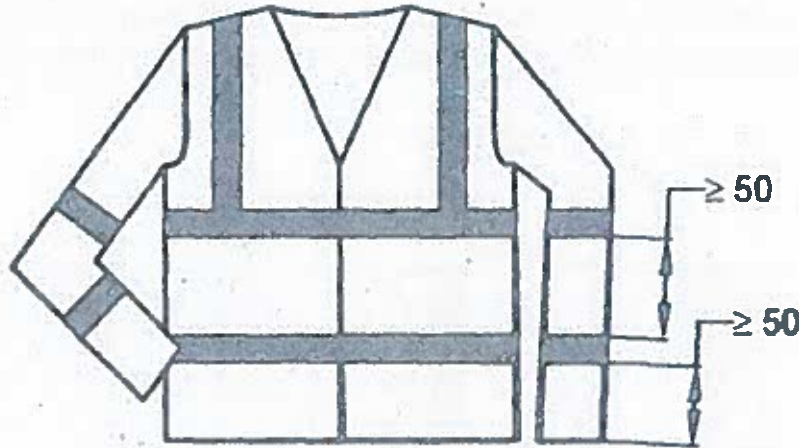

All dimensions in millimetres.

Fig. 1: Features of high visibility jackets

4.4. HIGH VISIBILITY VESTS

4.4.1. Design and Construction

- 4.4.1.1. The high visibility vests shall be designed, manufactured, stitched and constructed as per BS EN 1150 class 3 compliant, ISO 20471 - class 3 and fully conform to provisions of clauses 4.2.1 to 4.2.3.
- 4.4.1.2. The vest shall have front fastness construction for greater wearer comfort and manoeuvrability. Lower rise at the waist will be followed by the horizontal strip of reflection. Collar and throat tab shaped providing optimum compatibility.
- 4.4.1.3. It shall have a new shoulder shape and decreased side sleeve to allow full rotation mobility in shoulder and arm. There will be presence of side supporting fabric avoiding joints at side.
- 4.4.1.4. The arm cut shall be at reasonable distance such that the wearer shall find no obstacles in wearing or working with the vest. Polyamide zip fasteners with metallic stoppers on both ends shall be provided for closing and opening of the vest.
- 4.4.1.5. There shall be no joints at the side of the vest. The shoulder shall be over locked for extra fitting and strength. This will help to provide locking of any loose edges and that there shall be no migrations of colours on the reflective vests or the reflective tapes.

Issued by: Head of Section, Standard Development

Authorized by: Head of Department, Standards

Signed:



Signed:



Date: 2015-10-12

Date: 2015-10-12

4.4.1.6. 100% polyester three (3) ply thread shall be used for stitching and be matched wherever the colour combination is required. The vest shall provide for 360° visibility.

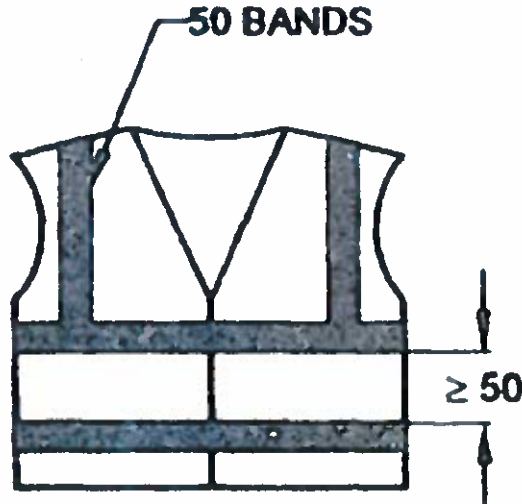

Fig. 2: Illustration of a high visibility vest

4.4.2. Background Fabric

- 4.4.2.1. The fabric content shall be Polyester-Cotton with 65% Polyester and 35% Cotton (+/- 5%). This fabric shall be ISO 20471 approved for colour fastness from a well-known testing laboratory (Test certificate to be submitted with the tender).
- 4.4.2.2. The background fabric shall be 65:35 Polyester Cotton pertaining to BS EN 1150 or ISO 20471 standards and shall have following features:-
- The basic fabric used shall be high visibility fluorescent dyed material (yellow in colour) for enhanced day time visibility consisting of 100% Polyester yarn in warp and 100% Cotton yarn in weft. So that polyester yarn in warp having high reflection property will project on the upper surface of the garment and cotton yarn in weft having low reflection property will remain in the inner surface of the garment and provide sufficient comfort to the wearer even though worn over regular clothing.
 - Blend Composition: The overall blend composition shall be 65:35 Polyester Cotton.
 - GSM: Mass of background material shall be 170 – 180 g/mm².
 - Comfort Level: The cotton yarn will remain in the inner portion of garment enhancing the comfort level of the wearer, even in hot conditions.

Issued by: Head of Section, Standard Development

Authorized by: Head of Department, Standards

Signed:



Signed:



Date: 2015-10-12

Date: 2015-10-12



TITLE:
**SPECIFICATION FOR
PERSONAL PROTECTIVE
EQUIPMENT - PROTECTIVE
CLOTHING**

Part 4: High visibility clothing

Doc. No.	KP1/6C/13/TSP/01/025-4
Issue No.	1
Revision No.	0
Date of Issue	2015-10-12
Page 11 of 19	

4.5. RETRO-REFLECTIVE LOGO AND SAFETY MESSAGE:

- 4.5.1. A PVC type retro-reflective Kenya Power logo - The logo used shall be visible in the dark and reflective when light falls on it thus creating the brand leverage and total visibility. Retro-reflective logo shall be stitched on front left upper side of the vest as shall be determined by the sample. The logo printing shall be done on the inner surface of micro prismatic reflective sheet and border to be sealed for better life of the logo.
- 4.5.2. A PVC type retro-reflective safety message "SAFETY FIRST" - This shall be of the same quality and performance as clause 4.5.1, symmetrically attached at the back of the vest, two thirds from the bottom edge of the vest.

4.6. SIZE DESIGNATION

- 4.6.1.1. Jackets used as protective clothing shall be marked with its size based on body dimensions measured in centimetres. Exceptions shall be specified in detail in the relevant product standards, e.g. Genital protectors for use in sports.
- 4.6.1.2. Measurement procedures and the designation of dimensions shall correspond to EN 13402. The size designation of each garment shall comprise the control dimensions for the chest or burst girth and height.
- 4.6.1.3. The sizes shall be as per Table 4a & b.

Table 4a: Size designation of Men's High Visibility Jackets and Vests

Size designation	Bust	Waist	Hip	Inseam	Height
XS	89-93	73-77	89-93	76	171-174
S	95-99	79-83	95-99	81	174-177
M	101-105	85-89	101-105	86	177-180
L	107-111	91-95	107-111	87	180-183
XL	113-117	97-101	113-117	91	183-186
XXL	119-123	103-107	119-123	92	186-189
XXXL	125-129	109-113	125-129"	96	189-192
XXXXL	131-135	115-119	131-135	96	192-195

All dimensions in centimetres, cm

Issued by: Head of Section, Standard Development

Authorized by: Head of Department, Standards

Signed:

Signed:

Date: 2015-10-12

Date: 2015-10-12



TITLE:

**SPECIFICATION FOR
PERSONAL PROTECTIVE
EQUIPMENT - PROTECTIVE
CLOTHING**

Part 4: High visibility clothing

Doc. No.

KP1/6C/13/TSP/01/025-4

Issue No.

1

Revision No.

0

Date of Issue

2015-10-12

Page 12 of 19

Table 4b: Size designation of Women's High Visibility Jackets and Vests

Size designation	Bust	Waist	Hip	Inseam	Height
S	89-93	69-73	93-97	79	166-169
M	95-99	75-79	99-103	81	169-172
L	101-105	81-85	105-109	83	172-175
XL	107-111	87-91	111-115	85	175-178
XXL	113-117	93-97	117-121	85	178-181

All dimensions in centimetres, cm

4.7. QUALITY MANAGEMENT SYSTEM

- 4.7.1. The supplier shall submit a quality assurance plan (QAP) that will be used to ensure that the design, material, workmanship, tests, service capability, maintenance and documentation of the high visibility jackets fulfil the requirements stated in the contract documents, standards, specifications and regulations. The QAP shall be based on and include relevant parts to fulfil the requirements of ISO 9001:2008.
- 4.7.2. The Manufacturer's Declaration of Conformity to applicable standards and copies of quality management certifications including copy of valid and relevant ISO 9001: 2008 certificate shall be submitted with the tender for evaluation.

5.0. TESTS AND INSPECTION

- 5.1. The high visibility clothing shall be inspected and tested in accordance with the requirements of ISO 2047, BS EN 420, BS EN 388, BS EN 12477, BS EN 407, BS EN 7318, applicable Kenyan standards and all the provisions of this specification. It shall be the responsibility of the supplier to perform or to have performed the tests specified and whatever other tests he normally performs at works.
- 5.2. Copies of previous Type Tests Reports issued by a third party testing laboratory that is accredited to ISO/IEC 17025 shall be submitted with the tender for the purpose of technical evaluation. The accreditation certificate to ISO/IEC 17025 for the same third party testing laboratory used shall also be submitted with the tender document (all in English Language). The type tests shall include:
- Material composition
 - Verification of gloves sizes
 - Abrasion resistant test
 - Blade cut resistance test

Issued by: Head of Section, Standard Development

Authorized by: Head of Department, Standards

Signed:

Signed:

Date: 2015-10-12

Date: 2015-10-12



TITLE:
**SPECIFICATION FOR
PERSONAL PROTECTIVE
EQUIPMENT - PROTECTIVE
CLOTHING**

Part 4: High visibility clothing

Doc. No.	KP1/6C/13/TSP/01/025-4
Issue No.	1
Revision No.	0
Date of Issue	2015-10-12
Page 13 of 19	

- e) Tear resistance test
- f) Puncture resistance test

5.3. The high visibilityclothings shall be subject to acceptance tests at the manufacturer's workshop before dispatch. Acceptance tests shall be witnessed by at least two (2) Tender Processing Committee members appointed by The Kenya Power and Lighting Company Limited (KPLC). Routine and Sample Test Reports for the high visibility jackets to be supplied shall be submitted to KPLC for approval before delivery of the goods. The tests to be witnessed shall include;

- a) Material composition
- b) Verification of gloves sizes
- c) Abrasion resistant test
- d) Blade cut resistance test
- e) Tear resistance test
- f) Puncture resistance test

5.4. On receipt of the gloves, KPLC will perform any of the tests specified in order to verify compliance with this specification. The supplier shall replace without charge to KPLC the high visibility jackets which upon examination, test or use; fail to meet any of the requirements in the specification.

6.0. MARKING AND PACKING

6.1. MARKINGS

6.1.1. The following information shall be printed on a suitable label firmly attached to each packaging:

- a) Purchase order number/tender
- b) Manufacturer's name
- c) Year of manufacture
- a) Pictogram symbol - each pictogram is followed by the levels of performance according to EN 407 and EN 388
- d) High visibility jackets catalog number
- e) The words, "PROPERTY OF KPLC"

6.1.2. Marking of high visibility clothing shall be in accordance with EN 420 and EN 12477:

- b) Each high visibility clothing shall be marked with standard number (EN 12477), followed by the letter of the type (A or B).
- c) The smallest packaging shall be marked with the pictogram of gloves for protection against thermal risks and (optional) mechanical risks with the number of the standard.

Issued by: Head of Section, Standard Development

Authorized by: Head of Department, Standards

Signed:

Signed:

Date: 2015-10-12

Date: 2015-10-12



TITLE:
**SPECIFICATION FOR
PERSONAL PROTECTIVE
EQUIPMENT - PROTECTIVE
CLOTHING**

Part 4: High visibility clothing

Doc. No.	KP1/6C/13/TSP/01/025-4
Issue No.	1
Revision No.	0
Date of Issue	2015-10-12
Page 14 of 19	

d) Each pictogram is followed by the levels of performance according to EN 407 and EN 388

6.2. PACKAGING

6.2.1. The high visibility clothing shall be packed in a manner so as to protect it from damage during transportation and storage. Instructions for storage and handling shall be included in each package, all in English Language.

7. DOCUMENTATION

7.1. The bidder shall submit its tender complete with technical documents required by Annex A (Guaranteed Technical Particulars) for tender evaluation. The technical documents to be submitted (all in English language) for tender evaluation shall include the following:

- a) Guaranteed Technical Particulars signed by the manufacturer;
- b) Copies of the Manufacturer's catalogues, brochures, drawings and technical data;
- c) Details of manufacturing capacity and the manufacturer's experience;
- d) Copies of required type test reports by a third party testing laboratory accredited to ISO/IEC 17025;
- e) Copy of accreditation certificate to ISO/IEC 17025 for the third party testing laboratory;
- f) Manufacturers letter of authorization, ISO 9001:2008 certificate and other technical documents required in the tender.

7.2. The successful bidder (supplier) shall submit the following documents/details to The Kenya Power & Lighting Company for approval before manufacture:

- a) Guaranteed Technical Particulars signed by the manufacturer;
- b) Design Drawings with details of high visibility clothing to be manufactured for KPLC.
- c) Quality assurance plan (QAP) that will be used to ensure that the design, material; workmanship, tests, service capability, maintenance and documentation will fulfill the requirements stated in the contract documents, standards, specifications and regulations. The QAP shall be based on and include relevant parts to fulfill the requirements of ISO 9001:2008
- d) Detailed test program to be used during factory testing;
- e) Marking details and method to be used in marking the high visibility clothing;
- f) Manufacturer's undertaking to ensure adequacy of the design, good engineering practice, adherence to the specification and applicable standards and regulations as well as ensuring good workmanship in the manufacture of the high visibility clothing for The Kenya Power & Lighting Company;

Issued by: Head of Section, Standard Development

Authorized by: Head of Department, Standards

Signed:

Signed:

Date: 2015-10-12

Date: 2015-10-12



TITLE:
**SPECIFICATION FOR
PERSONAL PROTECTIVE
EQUIPMENT - PROTECTIVE
CLOTHING**

Part 4: High visibility clothing

Doc. No.	KP1/6C/13/TSP/01/025-4
Issue No.	1
Revision No.	0
Date of Issue	2015-10-12
Page 15 of 19	

g) Packaging details (including packaging materials).

7.3. The supplier shall submit recommendations for use, care, storage and routine inspection/testing procedures, all in the English Language, during delivery of the high visibility clothing to KPLC stores.

-----SPACE LEFT BLANK-----

Issued by: Head of Section, Standard Development

Authorized by: Head of Department, Standards

Signed:

Signed:

Date: 2015-10-12

Date: 2015-10-12





TITLE:
**SPECIFICATION FOR
PERSONAL PROTECTIVE
EQUIPMENT - PROTECTIVE
CLOTHING**
Part 4: High visibility clothing

Doc. No.	KP1/6C/13/TSP/01/025-4
Issue No.	1
Revision No.	0
Date of Issue	2015-10-12
Page 16 of 19	

ANNEX A: Guaranteed Technical Particulars (to be filled and signed by the Manufacturer and submitted together with relevant copies of the Manufacturer's catalogues, brochures, drawings, technical data, sales records, four customer reference letters, the manufacturer's experience and copies of complete type test reports for tender evaluation, all in English Language)

Tender No.

Clause	Description	Guaranteed Technical Particulars offered	
	Name of Manufacturer & Country of manufacture	specify	
	Type/Model Reference Number		
	General requirements for High visibility clothing – ISO 20471	specify	
	Background material	Colour	specify
		Chromaticity coordinates	specify
		Gap width	specify
		Area covered	specify
	Retro-reflective material for logo and band	Colour	specify
		Chromaticity coordinates	specify
		Gap width	specify
		Area covered	specify
	Technology of manufacture	specify	
Performance requirements of background material	Colour fastness	Domestic and commercial laundering	specify
		Dry cleaning	specify
		Hot pressing	specify
		After xenon test	specify
	Colour coordinates	Colour	specify
		Chromaticity coordinates	specify
		Background luminance factor	specify
	Combined performance	specify	
Retro-reflective performance requirements	Abrasion		specify
	Flexing		specify
	Folding at cold temperatures		specify
	Temperatures variation		specify
	Washing		specify
	Dry cleaning		specify
	Convective Heat: RA ≥ 100		specify
	Wet Reflectivity: RA ≥ 100		specify
	Coefficient of retro-reflective material R', measured at observation angle 12' and entrance angle 5°		specify

Issued by: Head of Section, Standard Development	Authorized by: Head of Department, Standards
Signed: 	Signed: 
Date: 2015-10-12	Date: 2015-10-12



TITLE:
**SPECIFICATION FOR
PERSONAL PROTECTIVE
EQUIPMENT - PROTECTIVE
CLOTHING**

Part 4: High visibility clothing

Doc. No.	KP1/6C/13/TSP/01/025-4
Issue No.	1
Revision No.	0
Date of Issue	2015-10-12
Page 17 of 19	

		Coefficient of combined performance material R', measured at observation angle 12'and entrance angle 5°	specify	
		Coefficient of retro-reflection for retro-reflective material		
High visibility Jacket				
Standards of manufacture			specify	
Type designation or model as per catalogue number			specify	
Construction	Safety class as per ISO 20471 or BS EN 1150		specify	
	Water resistant		specify	
	Stretchable three layer construction		specify	
	Body material	Upper portion	specify	
		Lower portion	specify	
	Jacket lining	Material	specify	
		Properties	Breathable	specify
			Waterproof	specify
Windproof			specify	
Comfortable brushed fleece	specify			
Fabric materials	Background material		specify	
	Background contrasting material		specify	
	Retro-reflective material		specify	
Compliance to clauses 4.3.2.3 to 4.3.2.10			specify	
Collar design and dimensions			specify	
Zipper material and length			specify	
Zipper cover design and material			specify	
Hood design			specify	
Additional features	Zip closure with tunnel collar		specify	
	Zippered side waist pockets		specify	
	Zippered cell phone pocket at the chest		specify	
	Draw string hem with barrel lock		specify	
	Quick adjust rubber tab fastener with hook & loop cuffs		specify	
High visibility Vest				
Name of Manufacturer & Country of manufacture			specify	
Type/Model Reference Number			specify	
Standards of manufacture			specify	
General requirements for High visibility clothing – ISO 20471			specify	
Background material	Colour		specify	
	Chromaticity coordinates		specify	
	Gap width		specify	
	Area covered		specify	
Retro-reflective material for logo and band	Colour		specify	
	Chromaticity coordinates		specify	
	Gap width		specify	
	Area covered		specify	
	Technology of manufacture		specify	

Issued by: Head of Section, Standard Development

Authorized by: Head of Department, Standards

Signed:

Signed:

Date: 2015-10-12

Date: 2015-10-12



TITLE:
**SPECIFICATION FOR
PERSONAL PROTECTIVE
EQUIPMENT - PROTECTIVE
CLOTHING**

Part 4: High visibility clothing

Doc. No.	KP1/6C/13/TSP/01/025-4
Issue No.	1
Revision No.	0
Date of Issue	2015-10-12
Page 18 of 19	

		Certificate of approval by accredited laboratory to IEC/ISO 17025	specify	
		Minimum reflectivity, cd/lux	specify	
		Visibility distance, m	specify	
	Performance requirements of background material	Colour fastness	Domestic and commercial laundering	specify
			Dry cleaning	specify
			Hot pressing	specify
		Colour coordinates	After xenon test	specify
			Colour	specify
			Chromaticity coordinates	specify
	Retro-reflective performance requirements	Background luminance factor	Background luminance factor	specify
			Combined performance	specify
			Abrasion	specify
		Retro-reflective performance requirements	Flexing	specify
			Folding at cold temperatures	specify
			Temperatures variation	specify
Washing			specify	
Dry cleaning			specify	
Convective Heat: RA \geq 100			specify	
Wet Reflectivity: RA \geq 100			specify	
Retro-reflective performance requirements	Coefficient of retro-reflective material R', measured at observation angle 12'and entrance angle 5 $^{\circ}$	specify		
	Coefficient of combined performance material R', measured at observation angle 12'and entrance angle 5 $^{\circ}$	specify		
	Coefficient of retro-reflection for retro-reflective material	specify		
Construction	Comfort and maneuverability	specify		
	Collar and throat tab design	specify		
	New shoulder shape and decreased side sleeve to allow full rotation mobility in shoulder and arm	specify		
	Arm cut design	specify		
	No joints in the fabric	specify		
	Polyamide zip fasteners with metallic stoppers on both ends	specify		
	100% polyester 3-ply threading for stitching	specify		
Fabric material	Background fabric material	specify		
	Blend composition, %	specify		
	Colour	specify		
	Warp material	specify		
	Weft material	specify		
	Mass, g/mm 2	specify		
Comfort level	specify			
Size designation	Shall be as per table 6 conforming to EN 13402		Specify and attach a	

Issued by: Head of Section, Standard Development	Authorized by: Head of Department, Standards
Signed:	Signed:
Date: 2015-10-12	Date: 2015-10-12



TITLE:
**SPECIFICATION FOR
PERSONAL PROTECTIVE
EQUIPMENT - PROTECTIVE
CLOTHING**
Part 4: High visibility clothing

Doc. No.	KP1/6C/13/TSP/01/025-4
Issue No.	1
Revision No.	0
Date of Issue	2015-10-12
Page 19 of 19	

		drawing
4.5	Retro-reflective logo and safety message	specify
4.6.	Quality Management System	specify
	Quality Assurance Plan	provide
	Copy of ISO 9001:2008 Certificate	provide
	Manufacturer's experience	provide
	Manufacturing Capacity (units per month)	provide
	List of previous customers	provide
	Customer reference letters	provide
5.1	Test standards and responsibility of carrying out tests	provide
5.2	Copies of Type Test Reports submitted with tender	provide
5.3	Test reports to be submitted by supplier to KPLC for approval	provide
5.4	Replacement of rejected High visibility jackets and vests	specify
6.1	Marking	specify
6.2	Packing	specify
7.1	Documents submitted with tender	provide
7.2	Documents to be submitted by supplier to KPLC for approval before manufacture	provide
8.0	Manufacturer's Guarantee and Warranty	provide
9.0	List catalogues, brochures, technical data and drawings submitted to support the offer	provide
10.0	List customer sales records and reference letters submitted to support the offer.	provide
11.0	List Test Certificates submitted with tender	provide
12.0	List test reports of the wrenches to be submitted to KPLC for approval before shipment	provide
13.0	Statement of compliance to specification (indicate deviations if any & supporting documents)	provide

.....
Manufacturer's Name, Signature, Stamp and Date

NOTE:

The Guaranteed Technical Particulars (GTP), test reports & their certificates, drawings and/or catalogues shall form the basis of technical tender evaluation. Bidders shall ensure that the offered values for the item conform to the values in the test reports and their certificates, drawings, catalogue references and/or brochures. Failure to adhere by this requirement shall lead to automatic disqualification at the technical evaluation stage.

Issued by: Head of Section, Standard Development	Authorized by: Head of Department, Standards
Signed:	Signed:
Date: 2015-10-12	Date: 2015-10-12

